



Sapphire Double Door "Pass Through" Autoclave

Specifications for a Sapphire 550, 660 & 770 E & DS "DE" model

Design Features

- 550 (DS only) 660 & 770 litres
- MP25 Controller
- Square Chamber
- Automatic mechanically hoisted sliding door.
- Fixed Seal
- Space-saving design
- Accelerated water cooling by means of a water jacket.
- Interlocked Double doors

Optional Accessories

- Loading Trolley
- Range of cycle recording systems
- Drain Line Condenser for plastic drains
- Scale prevention systems
- Liquid Ring Vacuum air removal system
- Air Ballasting option
- Additional shelves & baskets
- Steam Jacket drying option
- Air removal HEPA filter (for CAT3 environments)
- Anti Lime scale system



Capacities and dimensions (approx)			
Model	Sapphire 550	Sapphire 660	Sapphire 770
Autoclave Weight	900 kg	1000 kg	1100 kg
Export Case Size	1140w x 2200h x 1910d	1140w x 2200h x 2000d	1140w x 2200h x 2300d
Overall Dimensions	980w x 1930h x 1695d	980w x 1930h x 1910d	980w x 1930h x 2100d
Chamber Dimensions	670w x 670h x 1099d	670w x 670h x 1247d	670w x 670h x 1455d
Chamber Capacity	550 Litres	660 Litres	770 litres
Water Consumption (Steam generator / typical per cycle)	45 litres	45 litres	45 litres
1L Media Bottles	108	132	156
2L Media Bottles	54	66	74
500ml Media Bottles	154	184	210
NHS Discard Boxes	H1012xW320xL320 (12)	H250xW320xL320 (12)	H250xW320xL320 (16)
Trolley	H671xW625xL1723	H671xW625xL1727	H671xW625xL1727

Not to scale

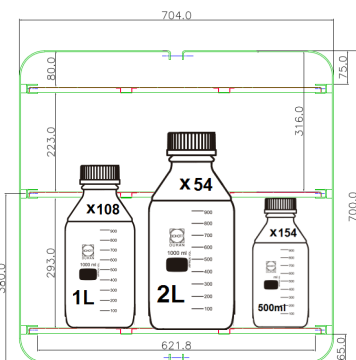
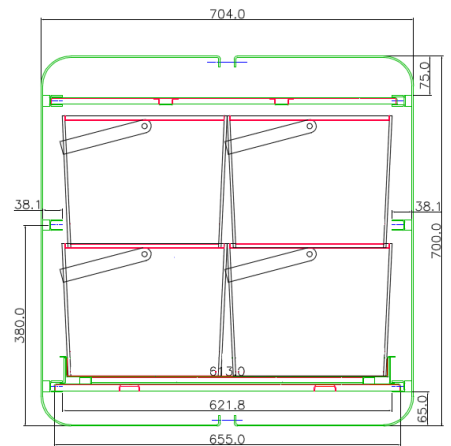

Sapphire 550

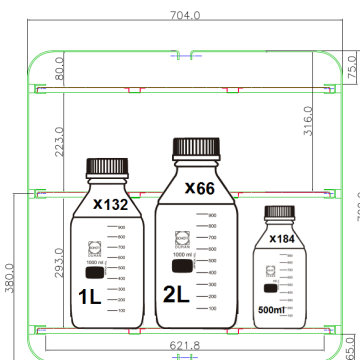

Sapphire 660

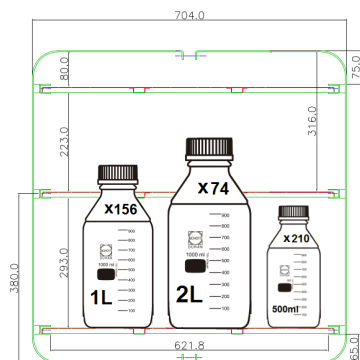

Sapphire 770

The Rodwell Autoclave Company

Human Scale

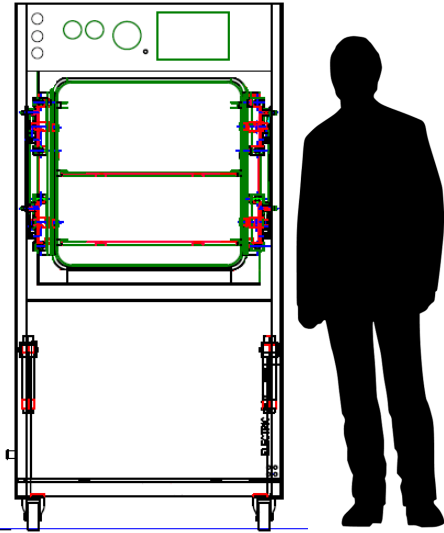

Safe Design Operating Limits

Model	Sapphire 550	Sapphire 660	Sapphire 770
Max working temperature	138 °C	138 °C	138 °C
Min working temperature	7 °C	7 °C	7 °C
Max ambient temperature	28 °C	28 °C	28 °C
Min ambient temperature	11 °C	11 °C	11 °C
Max hydraulic pressure	4.14 Bar	4.14 Bar	4.14 Bar
Max working pressure	2.62 Bar	2.62 Bar	2.62 Bar
Max working vacuum	Minus 1 Bar	Minus 1 Bar	Minus 1 Bar
Boiler hydraulic pressure	N/A	6 Bar	6 Bar
Boiler working pressure	N/A	4 Bar	4 Bar

Site Requirements (E Version)

Electrical site requirement: Switched RCD required

Model	Sapphire 660	Sapphire 770
Drain Requirements	150°C 35mmØ Copper	150°C 35mmØ Copper
Voltage	415v	415v
Phase Requirement	3ph/N 50/60 Hz	3ph/N 50/60 Hz
Power Consumption	36kw	36kw
Fuse Rating	60 amp	60 amp



Shown here are both sides of a double ended autoclave installation.

Site Requirements (DS Version)

Electrical site requirement: Switched RCD required

Model	Sapphire 550	Sapphire 660	Sapphire 770
Drain Requirements	150°C 35mmØ Copper	150°C 35mmØ Copper	150°C 35mmØ Copper
Mains Steam Supply	75 lbs p/h @ 2.67 Bar	75 lbs p/h @ 2.67 Bar	75 lbs p/h @ 2.67 Bar
Voltage	415v	415v	415v
Phase Requirement	3ph/N 50/60 Hz	3ph/N 50/60 Hz	3ph/N 50/60 Hz
Power Consumption	1.2kw	1.2kw	1.2kw
Fuse Rating	6amp	6amp	6amp

Option Requirements

- Air Supply at 38 psi, 7 cfm required for Air Ballasting option
- Steam Jacket drying option requires liquid ring vacuum option
- Drain requirement of 150°C, 35Ømm copper pipe at floor level.

General Requirements

- Air supply at 100psi 2cfm for pneumatic sliding door (+13amps for DS machines).
- Sodium Chloride must not exceed a level greater than 500 ppm.
- Use regular mains water only. DO NOT USE distilled or RO water
- DS Version requires a mains steam supply of 38psi 24kw 75lbs/hour



Installation Schematic Sapphire 550DE

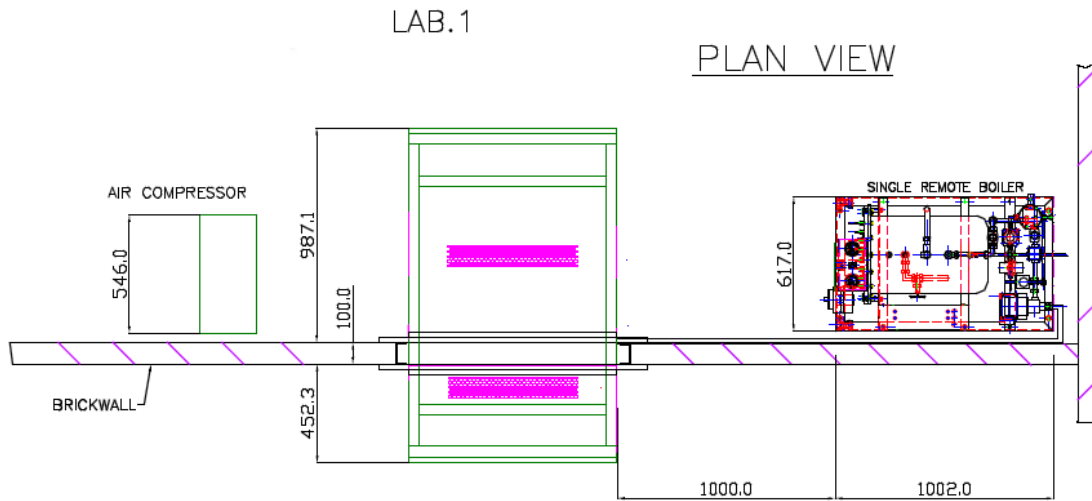

Installation Schematic Sapphire 660DE

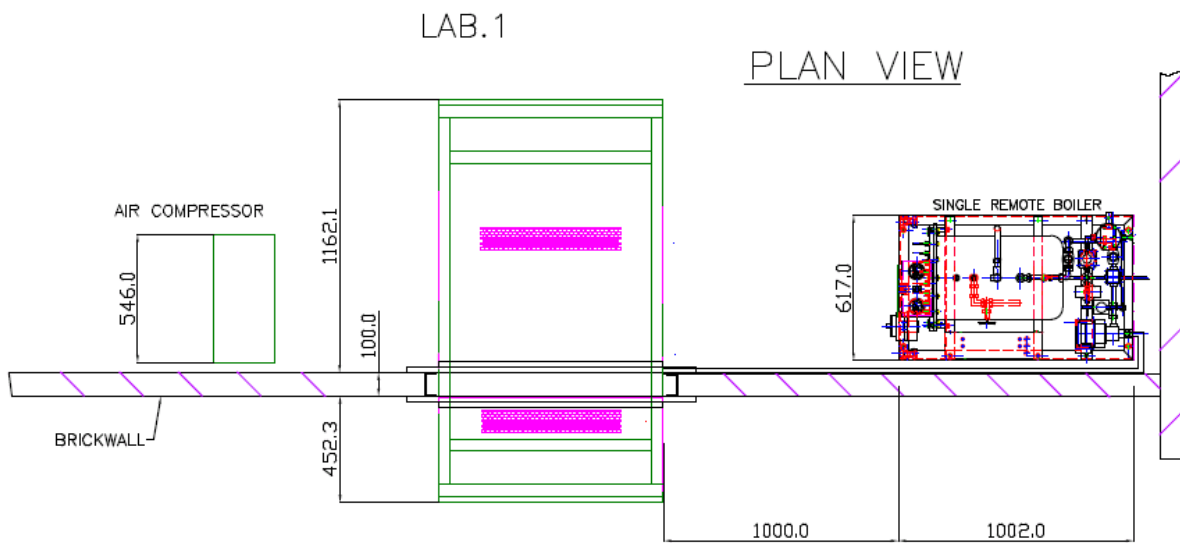

Installation Schematic Sapphire 770DE

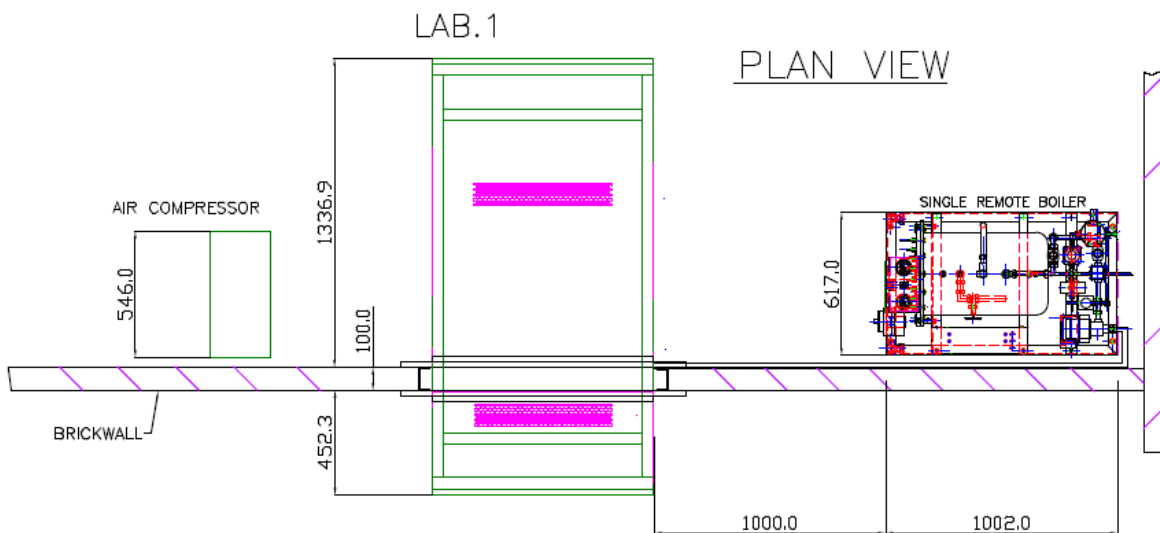

Example of double ended Sapphire in situ

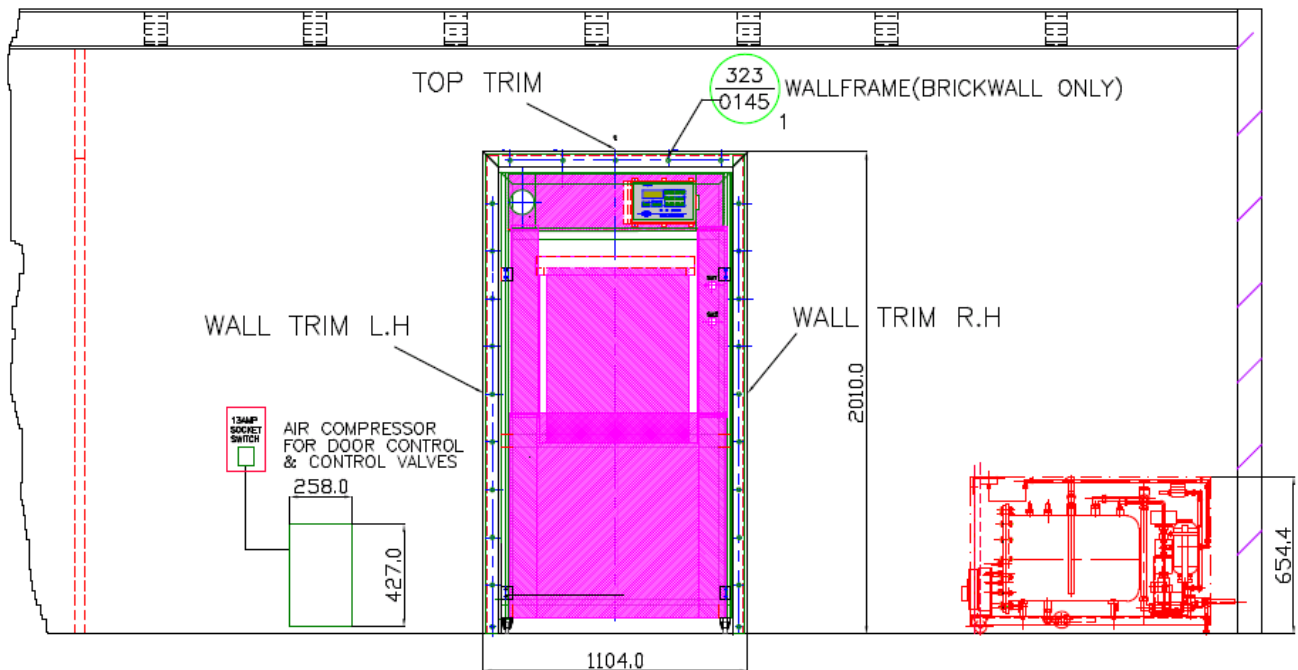

Complying Standards

- PED Cat 2 Module B+D Notified Body: British Engineering No. 0040
- Harmonised Standards applied: EMC BS EN 61326
- Community directives applied : Pressure Equipment Directive – PED 2014/68/EU (formerly PED 97/23/EC)
- Designed in accordance with PD5500 (formerly BS5500) & BS2646
- Chamber and Door constructed of stainless steel BS-EN 10028-7:316
- ISO 9001: 2008
- CE Marked

Information is subject to change to suit different options added. This information is correct as of 5th September 2017, E & OE



WolfLabs

Pricing on any accessories shown can be found by keying the part number into the search box on our website.

The specifications listed in this brochure are subject to change by the manufacturer and therefore cannot be guaranteed to be correct. If there are aspects of the specification that must be guaranteed, please provide these to our sales team so that details can be confirmed.

www.wolflabs.co.uk

Tel : 01759 301142

Fax : 01759 301143

sales@wolflabs.co.uk

Please contact us if this literature doesn't answer all your questions.